

NOTE: CONTACT RESISTANCE - 30 milliohm Max.
 INSULATION RESISTANCE - 100 Megaohm min.
 @500 VDC.
 DIELECTRIC STRENGTH - 500 VAC for one minute.
 LIFE CYCLE - 5,000 cycles min.
 INSERTION & EXTRACTION FORCE - 4 to 20N

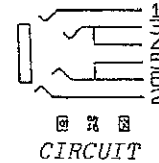
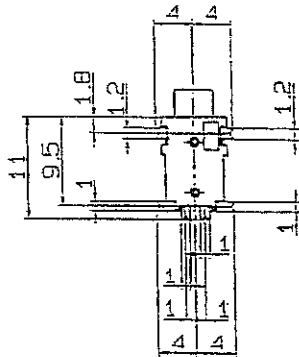
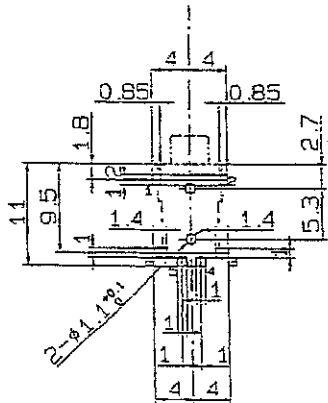
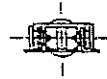
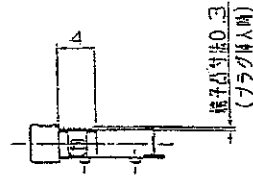
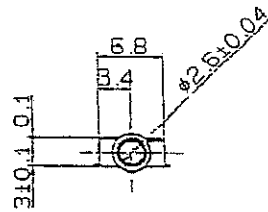
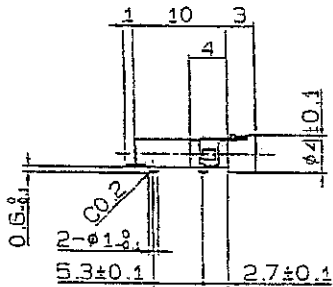

プリント基板半田付け部参考図 (公差±0.1mm)
 FOOT PRINT

7	HOUSING	1	PA46	BLACK	
6	TERMINAL R	1	銅合金 (COPPER ALLOY)	AG-P	t0.2
5	TERMINAL D	1	銅合金 (COPPER ALLOY)	AG-P	t0.25
4	TERMINAL C	1	銅合金 (COPPER ALLOY)	AG-P	t0.25
3	TERMINAL T	1	銅合金 (COPPER ALLOY)	AG-P	t0.25
2	TERMINAL A	1	銅合金 (COPPER ALLOY)	AG-P	t0.2
1	TERMINAL B	1	銅合金 (COPPER ALLOY)	AG-P	t0.2
NO	PART NAME	QTY	MATERIAL	FINISH	
承認 検図 設計 AOK R 画 2:1 作成日 2002. 7. 17 R.G					

SHOGYO INTERNATIONAL CORP.
 #M02-909A0