

X

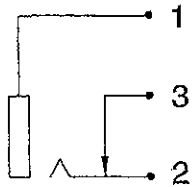

Y

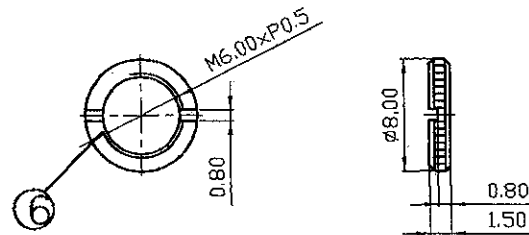
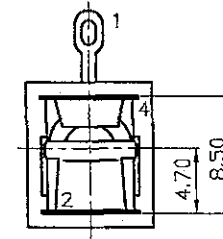
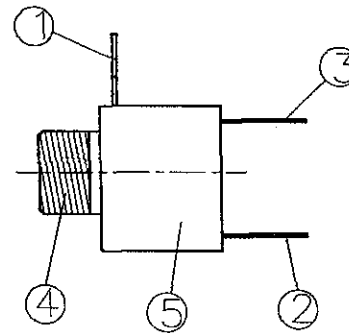
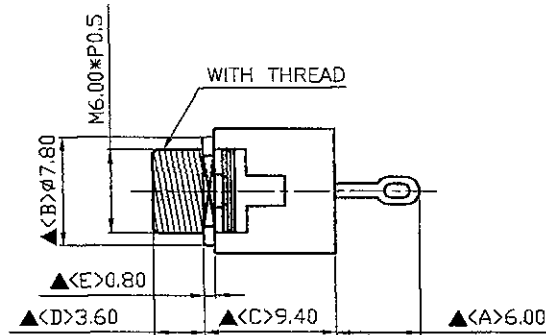
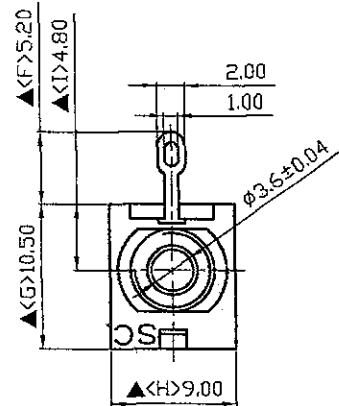

NUT

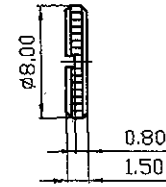

NO.	Description	Material	Q'TY	Finish
6	NUT	1.5T Brass	1	Nickel Plated
5	Housing	POM	1	Black Color
4	Barrel	Brass	1	Nickel Plated
3	Ring Spring	0.2T Phosphor Bronze	1	Silver Plated
2	Tip Spring	0.2T Phosphor Bronze	1	Silver Plated
1	Earth Terminal	0.3T Brass	1	Silver Plated

RoHS
Compliant

SPECIFICATIONS:
 Contact Resistance : 30mΩ max
 Insulation Resistance : 100MΩ min. at DC 500V
 Dielectric Withstanding Voltage: AC 500V for one minute
 Remark: ▲: The Most Important Dimension

DATE	DWN	CHKD
10.17.2011		

PART NAME : 3.5φ PHONE JACK

TOLERANCE : ±0.3mm UNLESS OTHERWISE SPECIFIED

UNIT:mm



SHOGYO INTERNATIONAL CORP.

#SCJ311MIN(*)S1B00G