

Arrangement of Contact

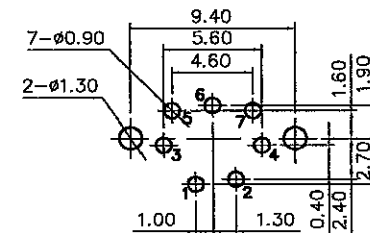
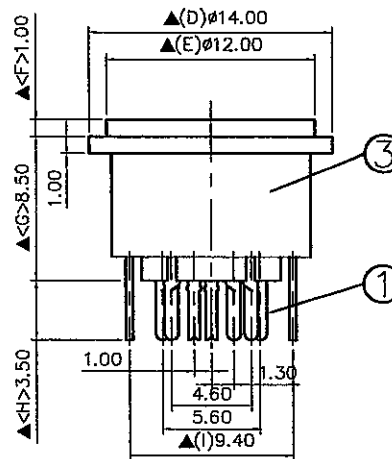

Pin Hole Layout  
(Jack Bottom View)

3.	Housing	PBT	1	Black Color
2.	Shell	0.4T Brass	1	Nickel Plating
1.	Terminal	0.2T Phosphor Bronze	7	Silver Plating
NO.	Description	Material	Q'TY	Finish

RoHS Compliant For Reference  
僅供參考

SPECIFICATIONS:  
 Contact Resistance : 30mΩ max  
 Insulation Resistance : 100MΩ min. at DC 500V  
 Dielectric Withstanding Voltage: AC 500V for one minute  
 Remark: ▲: The Most Important Dimension

DATE	DWN	CHKD	APVD	MANAGER
10.19.2011				

PART NAME :DIN JACK		VERSION:4.0	
TOLERANCE :±0.3mm UNLESS OTHERWISE SPECIFIED		UNIT:mm	SCALE:1/1

**SHOGYO INTERNATIONAL CORP.**

**#SCN570S7NS00000G**