

Arrangement of Contact

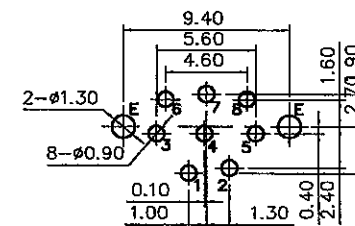
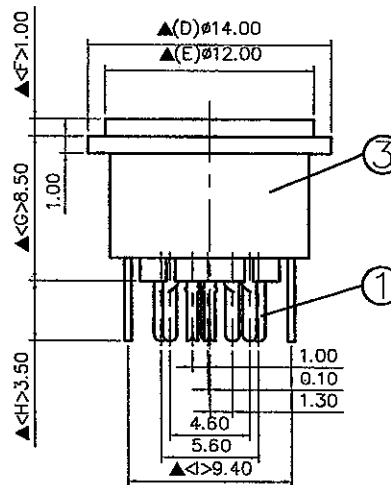

Pin Hole Layout
(Jack Bottom View)

3.	Housing	PBT	1	Black Color
2.	Shell	0.4T Brass	8	Nickel Plating
1.	Terminal	0.2T Phosphor Bronze	1	Silver Plating
NO.	Description	Material	Q'TY	Finish

DATE	DWN	CHKD	APVD	MANAGER
10.19.2011				

PART NAME :DIN JACK	VERSION:4.0
TOLERANCE :±0.3mm UNLESS OTHERWISE SPECIFIED	UNIT:mm SCALE:1/1

RoHS Compliant For Reference
僅供參考

SPECIFICATIONS:
 Contact Resistance : 30mΩ max
 Insulation Resistance : 100MΩ min. at DC 500V
 Dielectric Withstanding Voltage: AC 500V for one minute
 Remark: ▲: The Most Important Dimension

SHOGYO INTERNATIONAL CORP.

#SCN570S8NS00000G