

Arrangement of Contact

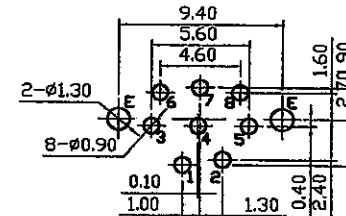
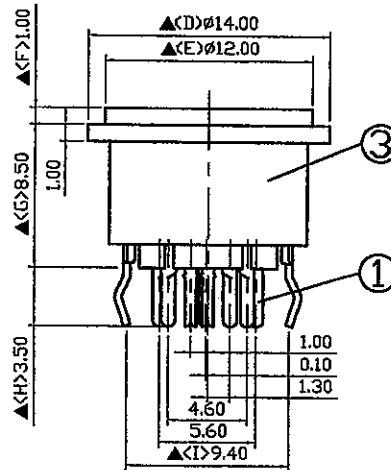

Pin Hole Layout
(Jack Bottom View)

3.	Housing	PBT	1	Black Color
2.	Shell	0.4T Brass	2	Nickel Plating
1.	Terminal	0.2T Phosphor Bronze	8	Silver Plating
NO.	Description	Material	Q'TY	Finish

		DATE	DWN	CHKD	APVD	MANAGER
		06.19.2014	謝齊輝			
PART NAME :DIN JACK			VERSION:1.0			
TOLERANCE :±0.3mm UNLESS OTHERWISE SPECIFIED			UNIT:mm		SCALE:1/1	

SPECIFICATIONS:

Contact Resistance : 30mΩ max
 Insulation Resistance : 100MΩ min. at DC 500V
 Dielectric Withstanding Voltage: AC 500V for one minute
 Remark: ▲: The Most Important Dimension

RoHS
Compliant

SHOGYO INTERNATIONAL CORP.
#SCN572S8NS00003G