

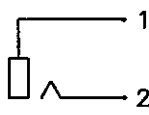

SCHEMATIC	
MODEL NO	U

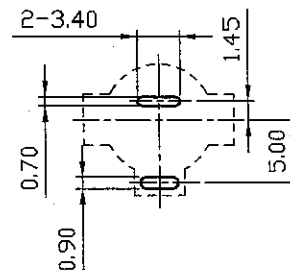
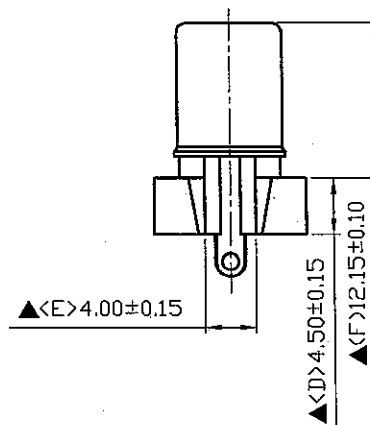
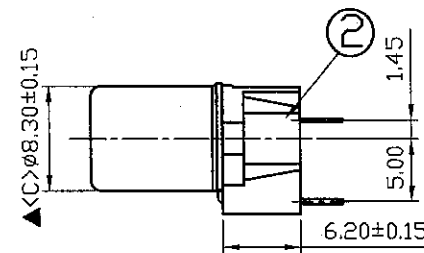
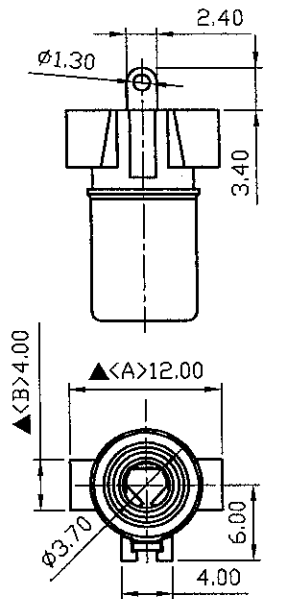
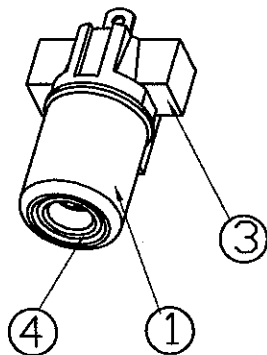

Pin Hole Layout  
(Jack Bottom View)

NO.	Description	Material	Q'TY	Finish
4.	Insulator	PBT	1	Black Color
3.	Housing	PA66+30%G	1	Black Color
2.	Pin	0.25T Brass	1	Silver Plated
1.	Earth Terminal	0.4T Brass	1	Nickel Plated

		DATE	DWN	CHKD
		09.25.2007		
PART NAME: PIN JACK				
TOLERANCE: $\pm 0.3\text{mm}$ UNLESS OTHERWISE SPECIFIED UNIT: mm 				

RoHS  
Pb Free Process

For Reference  
僅供參考

SPECIFICATIONS:  
 Contact Resistance : 30mΩ max  
 Insulation Resistance : 100MΩ min. at DC 500V  
 Dielectric Withstanding Voltage: AC 1500V for one minute  
 Remark: ▲: The Most Important Dimension

**SHOGYO INTERNATIONAL CORP.**  
 # SCP609UNS10000G