

**SPECIFICATIONS**

CONTACT RATING:Q: 1A @120 VAC or 28 VDC  
 ELECTRICAL LIFE: 50,000 make-and-break cycles at full load  
 CONTACT RESISTANCE: 20 mΩ max. initial @2-4 VDC,100 mA  
 INSULATION RESISTANCE: 1,000 MΩ min.  
 DIELECTRIC STRENGTH: 1,500 V RMS @ sea level.  
 OPERATING TEMPERATURE: -30°C to +85°C

**MATERIALS**

CASE - diallyl phthalate ( DAP )  
 PLUNGER - thermoplastic polyester  
 BUSHING - Copper alloy , nickel plated  
 HOUSING - Stainless Steel  
 CONTACT AND TERMINAL - Copper alloy , silver plated  
 SWITCH SUPPORT - Copper alloy , tin plated

**How do you build the switches you need!!**

The TS-21 / TS-22 , please see the (A) ;

The TS-21A/TS-21B/TS-22A/TS-22B, please see the (B)

(A) T S - 2 1 - C V     - 2 -     S     B     Q - E - A 5     -    

Switches Function		Cap or Actuator		Cap color		Plunger		Termination		Vertical support Bracket	
TS-21	SPST off-mom.	(none)	none	1	white	(none)	std.	B	solder lug	(none)	(std)straight type
TS-22	SPDT on-mom.	CV	5.08	2	black	FP	flush type	C	P.C	A5	(std)straight type snap-in type
		CV1	7.62	3	red			D	wire wrap	A5S	
		F22A	With frame	4	orange						
				5	yellow	<b>Bushing</b>		<b>Contact Material</b>		<b>RoHS code</b>	
				6	green	S	10-48 thd.(FLAT) 5.59	Q	silver plated	H = RoHS Compliant	
				7	Blue	U	none thd.(FLAT) 5.59	R	gold plated		
				8	Gray	T	none thd.(ROUND) 5.59	G	gold over silver		
				9	Gray	V	1/4-40 thd. 7.87	K	gold / tin		
						V1	none thd. 7.87	<b>Epoxy seal</b>			
						S9	flush	(none)	none seal		
								E	epoxy seal		

(B) T S - 2 1 A - C V 1 - 2 -     U     Q - E -     -    

Horizon Right Angle	Vertical Right Angle	Switches Function	Cap		Plunger		Epoxy seal	
TS-21A	TS-21B	SPST off-mom.	(none)	none	(none)	std.	(none)	none seal
TS-22A	TS-22B	SPDT on-mom.	CV	5.08	FP	flush type	E	epoxy seal
			CV1	7.62				
			<b>Cap color</b>		<b>Bushing</b>		<b>Support Bracket</b>	
			1	white	S	10-48 thd.(FLAT) 5.59	(none)	Std. straight type
			2	black	U	none thd.(FLAT) 5.59	S	snap-in type
			3	red	T	none thd.(ROUND) 5.59		
			4	orange	S9	flush		
			5	yellow	<b>Contact Material</b>		<b>RoHS code</b>	
			6	green	Q	silver plated	H = RoHS Compliant	
			7	Blue	R	gold plated		
			8	Gray	G	gold over silver		
			9	Gray	K	gold / tin		

INDEX

TOGGLE

ROCKER

SLIDE

PUSH BUTTON

DIP

TACT

SPST

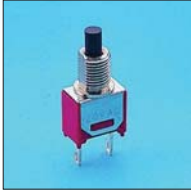

Model No.	Switching position	
TS-21	Off	Mom
Term. Comm.	open	1-3

SCHEMATIC

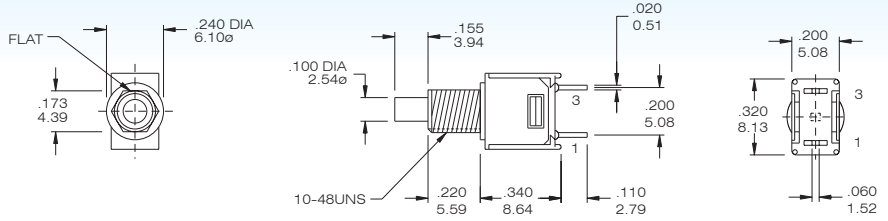

TS-21- SBQ

SPST



Model No.	Switching position	
TS-21A	Off	Mom
Term. Comm.	open	1-3

SCHEMATIC

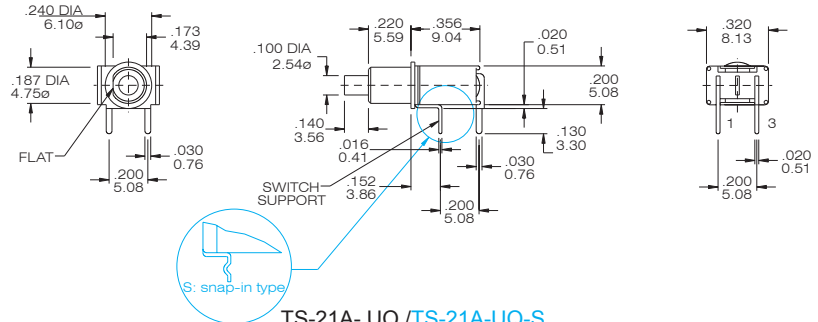

TS-21A- UQ / TS-21A-UQ-S

SPST



Model No.	Switching position	
TS-21B	Off	Mom
Term. Comm.	open	1-3

SCHEMATIC

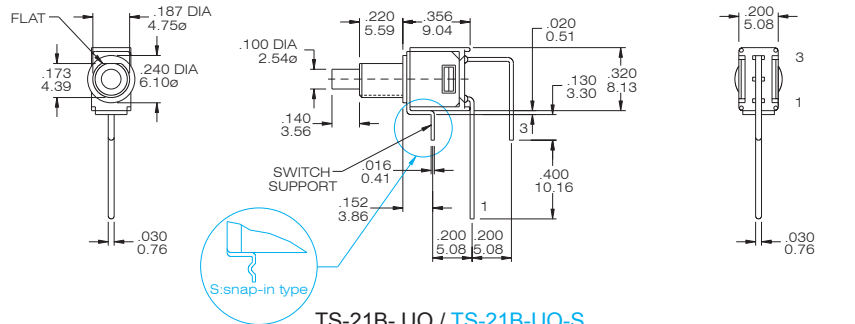

TS-21B- UQ / TS-21B-UQ-S

SPDT



Model No.	Switching position	
TS-22	On	Mom
Term. Comm.	2-1	2-3

SCHEMATIC

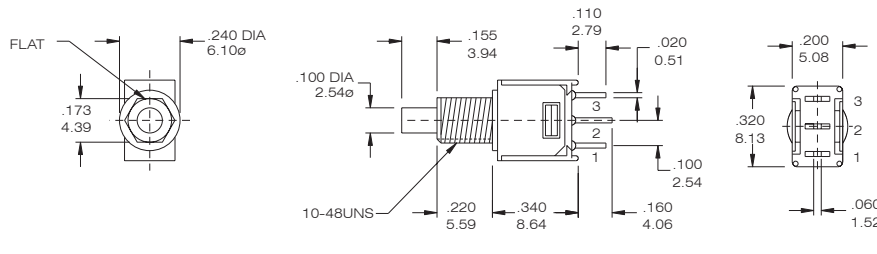

TS-22- SBQ

SPDT



Model No.	Switching position	
TS-22A	On	Mom
Term. Comm.	2-1	2-3

SCHEMATIC

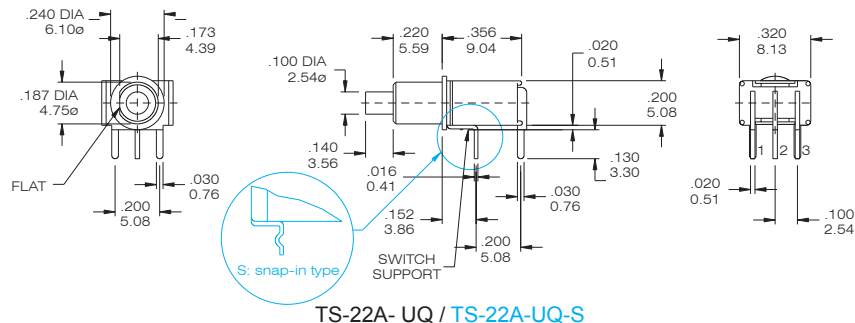

TS-22A- UQ / TS-22A-UQ-S

SPDT



Model No.	Switching position	
TS-22B	On	Mom
Term. Comm.	2-1	2-3

SCHEMATIC

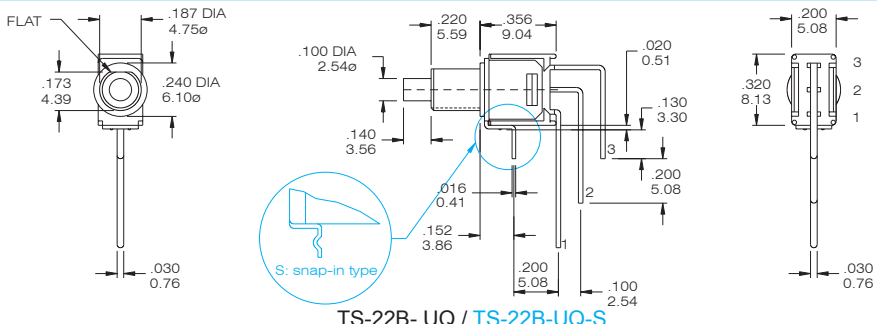

TS-22B- UQ / TS-22B-UQ-S

Cap and Actuator Option

Cap color Option

CV

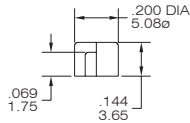

CV1

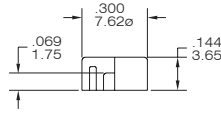

Plunger:  
FP flush type

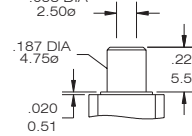

CAP & ACTUATOR OPTIONS	
1	White
2	Black(Std.)
3	Red
4	Orange
5	Yellow
6	Green
7	Blue
9	Gray

F22A

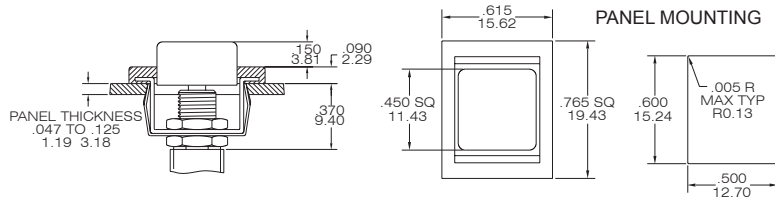

Bushing Option

S

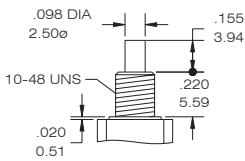
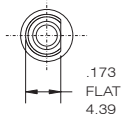

U

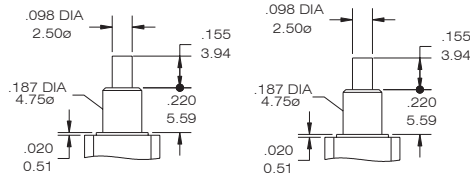
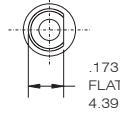

T

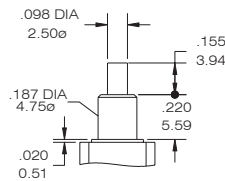

V : Thd.  
V1 : Non Thd.

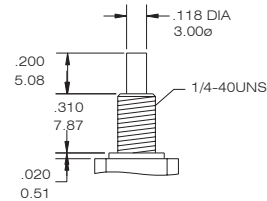
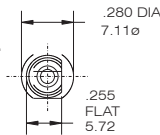

S9

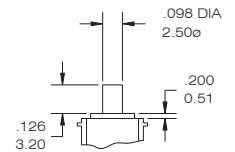

TERMINAL OPTION ( ONLY FOR THE TS-21 / TS-22 )

Terminal Seal Option

B Solder Lug(STD)

C PRINTED CIRCUIT

D Wire Wrap

-E Terminal Seal

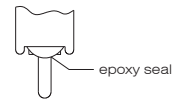
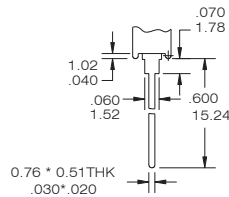
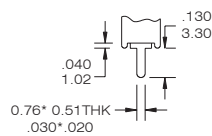
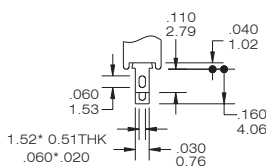

P.C.B MOUNTING DIMENSION

PANEL MOUNTING DIMENSION

TS-21 (PC terminal)

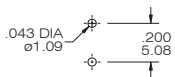

TS-21A

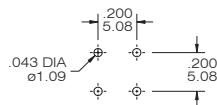

TS-21B

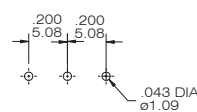

10-48 BUSHING

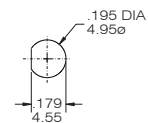

TS-22 (PC terminal)

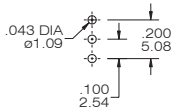

TS-22A

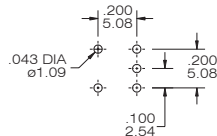

TS-22B

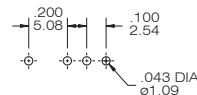

1/4 IN. BUSHING

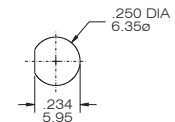

CONTACT MATERIAL OPTIONS

CODE	CONTACT MATERIAL	TERMINAL MATERIAL	RATING
Q	Silver plated	Silver plated	1A @ 120V AC or 28 V DC
R	Gold plated over nickel plated	Gold plated over nickel plated	0.4VA MAX @ 20 V AC or DC MAX
G	Gold plated over silver plated	Gold plated over silver plated	0.4 VA MAX @ 20 V AC or DC MAX or 1A @ 120V AC or 28 V DC
K	Gold plated over nickel plated	Tin over nickel plated	0.4VA MAX @ 20 V AC or DC MAX

\* THE K option is only for some special item. Please inquire first when you need the "K" option

VERTICAL SUPPORT BRACKET OPTION

Only for the TS21/TS22 . If you need the vertical support bracket , Choose the terminal option in "C" code

INDEX

TOGGLE

ROCKER

SLIDE

PUSH BUTTON

DIP

TACT

A5/ A5S

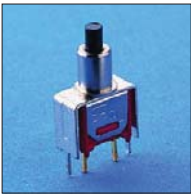

SPST

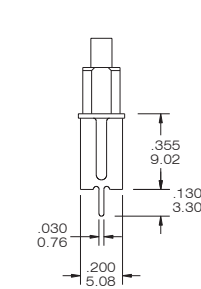

TS-21-UCQ-A5

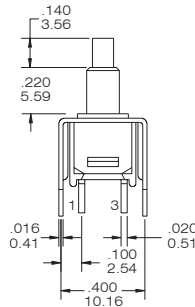

A5 (STD.)

P.C. MOUNTING

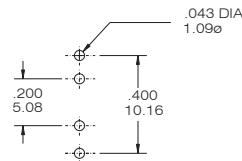

A5S (Snap-in)

A5/ A5S



SPDT

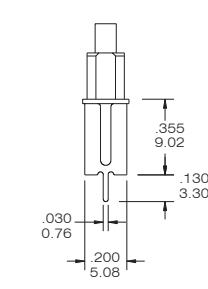

TS-22-UCQ-A5

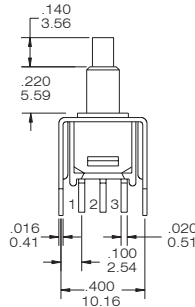

A5 (STD.)

P.C. MOUNTING

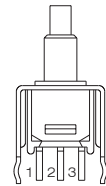
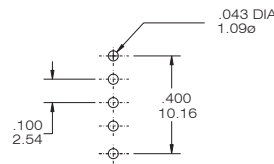

A5S (Snap-in)