

SCHEMATIC	
MODEL NO	C

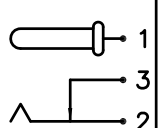
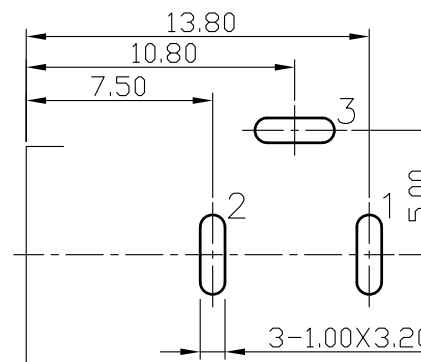
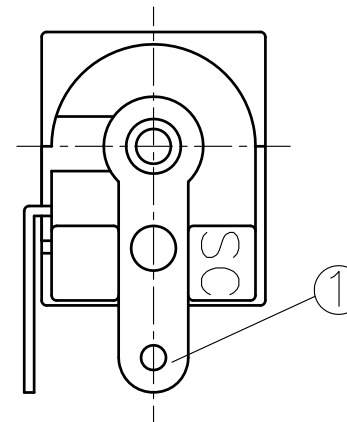
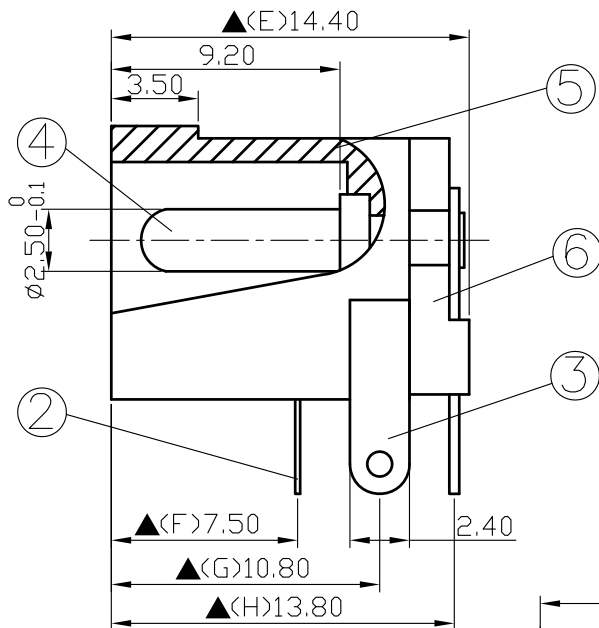
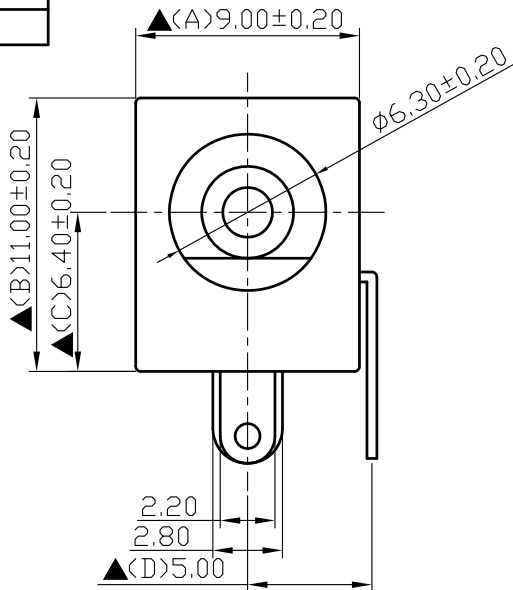

Pin Hole Layout
(Jack Bottom View)

6.	Cover	PBT+30%	1	Black Color
5.	Housing	PBT+30%	1	Black Color
4.	Pin(2.5φ)	Brass	1	Nickel Plated
3.	Break Terminal	0.4T Brass	1	Silver Plated
2.	Sleeve Spring	0.2T Phosphor Bronze	1	Silver Plated
1.	Pin Terminal	0.4T Brass	1	Silver Plated
NO.	Description	Material	Q'TY	Finish

For Redference
僅供參考

RoHS&SVHC
Compliant



DATE	DWN	CHKD	APVD	MANAGER
09.28.2021	王平華			

PART NAME :DC POWER JACK

PART NUMBER:SCD441DCS011B00G

VERSION:8.0

TOLERANCE :±0.3mm UNLESS OTHERWISE SPECIFIED

UNIT:mm

SCALE:1/1

SPECIFICATIONS:
 Contact Resistance : 30mΩ max
 Current Rating : Max 5.0A, 24V DC
 Insulation Resistance : 100MΩ min. at DC 500V
 Dielectric Withstand Voltage : AC 500V for one minute
 Remark: ▲: The Most Important Dimension