

SCHEMATIC	
MODEL NO	C

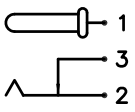
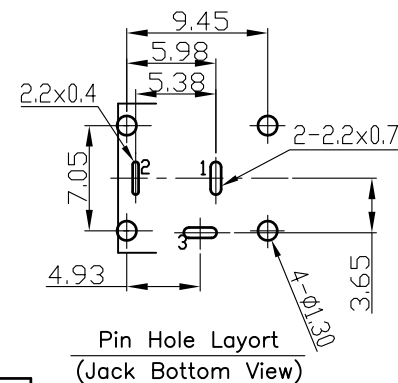
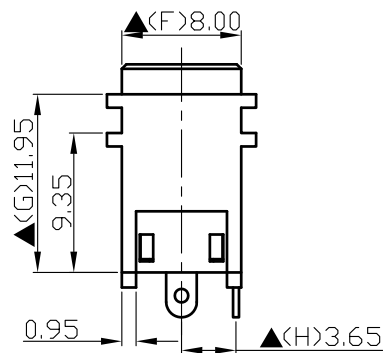
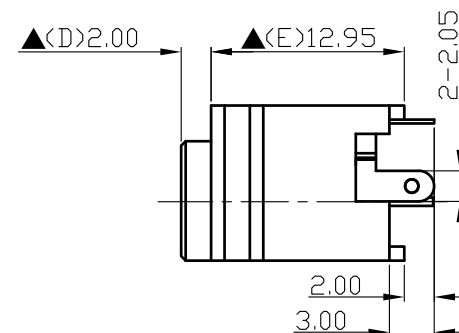
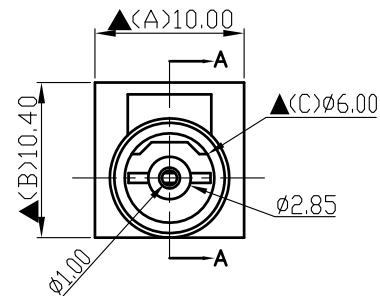
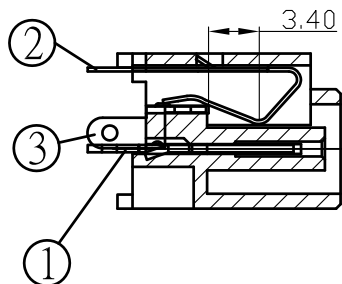
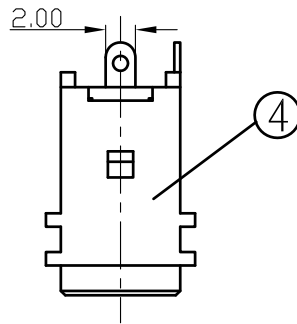

4.	Housing	PBT+30%(UL94-V0)	1	Black Color
3.	Break Terminal	0.4T Brass	1	Silver Plated
2.	Ping Spring	0.25T Phosphor Bronze	1	Silver Plated
1.	Pin Terminal	0.5T Brass	1	Silver Plated
NO.	Description	Material	Q'TY	Finish

DATE	DWN	CHKD	APVD	MANAGER
09.09.2021	王平華			

# SHOGYO

For Reference  
僅供參考

RoHS&SVHC  
Compliant

PART NAME : DC POWER JACK

PART NUMBER: SCD462ECS000B02G

VERSION:2.0

TOLERANCE :±0.3mm UNLESS OTHERWISE SPECIFIED

UNIT:mm 

SCALE:1/1

**SPECIFICATIONS:**

Contact Resistance : 30mΩ max  
 Current Rating : Max 5.0A ,24VDC  
 Insulation Resistance : 100MΩ min. at DC 500V  
 Dielectric Withstand Voltage : AC 500V for one minute  
 Remark: ▲: The Most Important Dimension