

SCHEMATIC	
MODEL NO	C

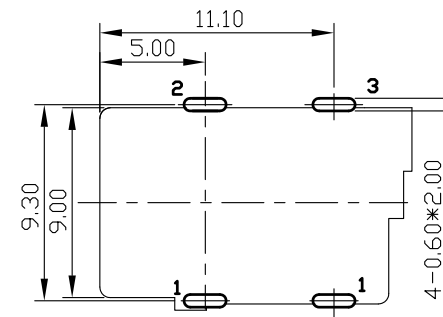

Pin Hole Layout
(Jack Bottom View)

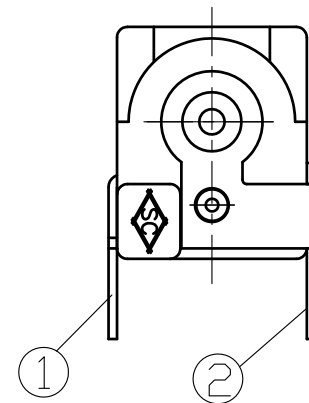
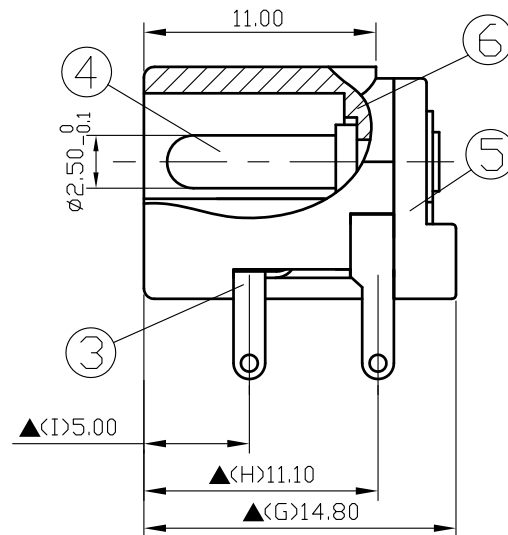
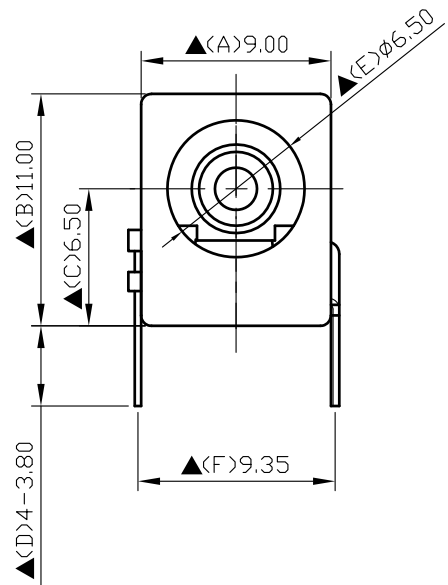
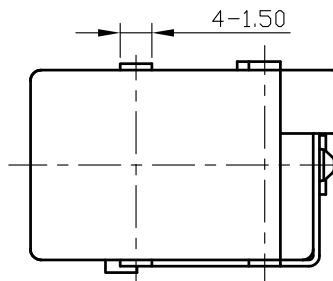

6.	Housing	PA9T	1	Black Color
5.	Cover	PA9T	1	Black Color
4.	Pin(2.5 ϕ)	Brass	1	Nickel Plated
3.	Sleeve Spring	0.3T Phosphor Bronze	1	Silver Plated
2.	Pin Terminal	0.3T Brass	1	Silver Plated
1.	Break Terminal	0.4T Brass	1	Silver Plated
NO.	Description	Material	Q'TY	Finish

SHIGYO

DATE	DWN	CHKD	APVD	MANAGER
10.11.2021	王平華			

For Redference
僅供參考

RoHS&SVHC
Pb Free Process

PART NAME :DC POWER JACK

PART NUMBER:SCD481DCS011B00G

VERSION:7.0

TOLERANCE : ± 0.3 mm UNLESS OTHERWISE SPECIFIED

UNIT:mm

SCALE:1/1

SPECIFICATIONS:

Contact Resistance : 30m Ω max
 Current Rating : Max 5.0A , 24VDC
 Insulation Resistance : 100M Ω min. at DC 500V
 Dielectric Withstand Voltage : AC 500V for one minute
 Remark: ▲: The Most Important Dimension